



Dell Pro Stereo Headset UC350

User's Guide

Regulatory model: UC350



Notes, cautions, and warnings

-  **NOTE:** A NOTE indicates important information that helps you make better use of your computer.
-  **CAUTION:** A CAUTION indicates potential damage to hardware or loss of data if instructions are not followed.
-  **WARNING:** A WARNING indicates a potential for property damage, personal injury, or death.

Copyright © 2017 Dell Inc. All rights reserved. This product is protected by U.S. and international copyright and intellectual property laws. Dell™ and the DELL logo are trademarks of Dell Inc. in the United States and/or other jurisdictions. All other marks and names mentioned herein may be trademarks of their respective companies.

2017 – 03

Rev. A00

Contents

About your headset	5
Product features	5
Noise-cancelling mic	5
3.5mm jack for better connectivity	5
Plug-and-play setup.	5
Made for voice and music.	5
Passive noise cancellation	5
Easy call management	5
What's in the box	6
Features	7
Headset.	7
Call-control Unit.	8
Setting up your headset	9
Plug the headset into your smartphone or tablet	9
Plug the headset into your computer	9
Configure the headset on your Computer.	10
Configuration for Skype for Business.	10
Configuration for other softphones.	10
Configuration to listen to music.	10
Adjusting the headset	12
Answering/ending a call	13
Answer an incoming call on the computer	13
End an incoming call on the computer	13
Adjusting the volume.	14

- Muting/unmuting a call 14
- Troubleshooting 15**
 - Common symptoms 15
- Specifications. 18**
 - General 18
 - Physical characteristics 18
 - Environmental 18
- Statutory information. 19**
 - Warranty 19
 - Limited warranty and return policies 19
 - For U.S. customers: 19
 - For European, Middle Eastern and African customers: 19
 - For non-U.S. customers: 19

About your headset

Product features

The features of the Dell Professional Stereo Headset UC350 include:

Noise-cancelling mic

State-of-the-art, noise-cancelling microphone eliminates background noise. Your conversation partner won't struggle to hear what you're saying.

3.5 mm jack for better connectivity

The 3.5 mm jack lets users connect to their personal devices - such as a smartphone or tablet - to work or listen to music wherever they may be.

Plug-and-play setup

Works out of the box with all leading systems. Installation is as easy as plugging the headset to your device.

Made for voice and music

World-class speakers built for both voice and music. Quickly and easily switch between conversing and listening to your favorite tracks.

Passive noise cancellation

Simply wear the headset to eliminate high-frequency noise, such as human voices - all thanks to the specially designed ear cushions. We call this "passive noise cancellation".

Easy call management

The call controller offers access to large buttons and easy-to-see LED indicators. Answer or end calls, control the volume, or simply mute the call.

What's in the box

 **NOTE:** The documents shipped with the headset may vary based on your region.

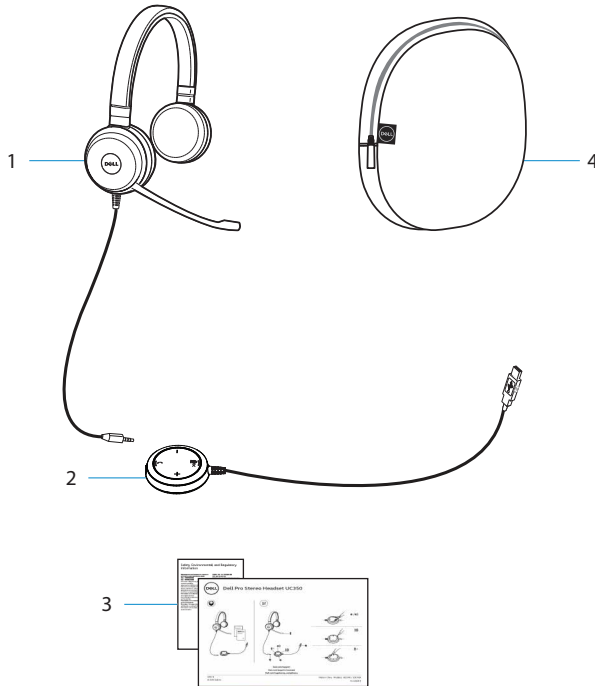

1 Headset

2 USB controller

3 Documents

4 Travel pouch

Features

Headset

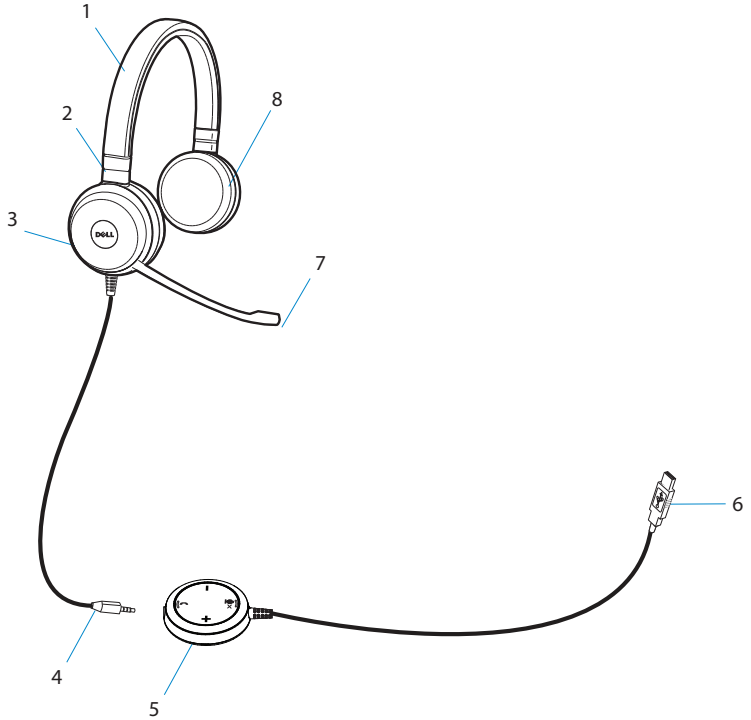

1	Headband	2	Adjustable speaker chambers
3	Speaker	4	3.5 mm jack
5	Call control unit	6	USB plug
7	Noise cancelling microphone	8	Speaker

Call-control Unit

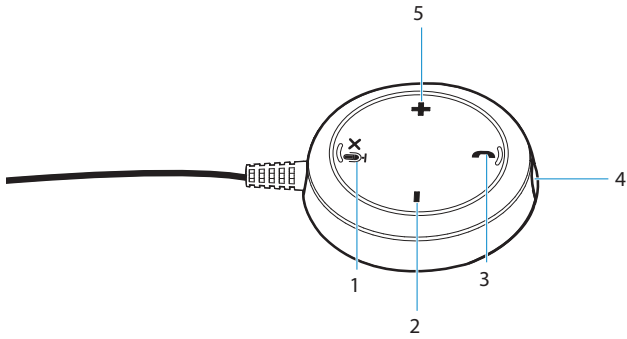

1	Mute button	2	Volume down button
3	Phone button	4	3.5 mm port
5	Volume up button		

Setting up your headset

Plug the headset into your smartphone or tablet

Plug the headset into a 3.5 mm jack port on your smartphone or tablet.



Plug the headset into your computer

Plug the headset into a USB port on your computer.

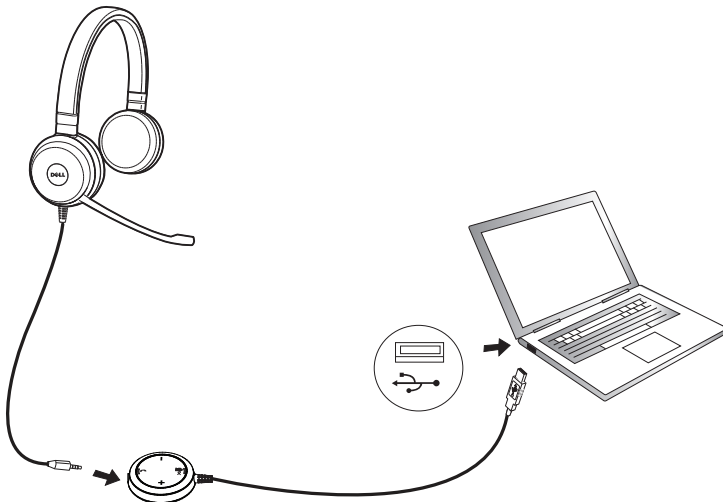

Configure the headset on your Computer

Configuration for Skype for Business

The Dell Pro Stereo Headset UC350 is certified and optimized for Skype for Business. Connect the headset to your device via USB. Once the headset is detected, it is ready to use.

Configuration for other softphones

The Dell Pro Stereo Headset UC350 is also certified and optimized for all leading Unified Communications platforms. First, you have to install the Jabra Direct software application on your computer to be able to use the call-control unit functionalities.

1. Connect the headset to your computer via USB.
2. Download the latest release of Jabra Direct at www.jabra.com/direct and follow the installation guide at www.dell.com/support.
3. Once done, the headset is ready to use.

Configuration to listen to music

To use your headset to listen to music from your computer, the headset has to be selected as the default playback device in Windows Audio Settings.

1. Right click on the speaker icon on the Windows toolbar to access the Windows Audio Settings.

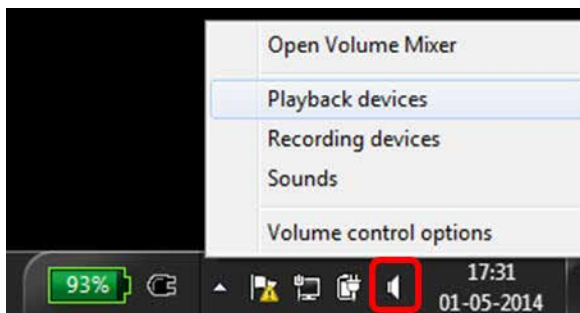

2. Set the Headset Earphone (Dell Pro Stereo Headset UC350) as the Default Playback Device.

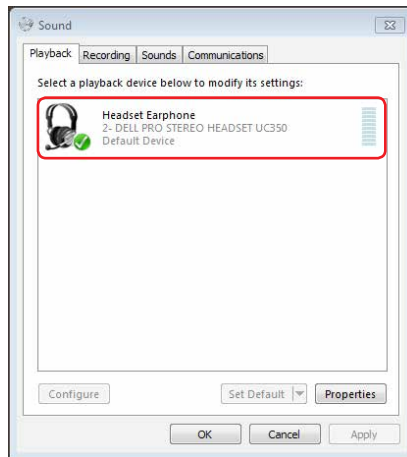

Adjusting the headset

Adjust the headband to get the optimal fit for your headset. Adjust the headset boom arm to have the microphone around 2 centimeters (cm) away from the mouth.

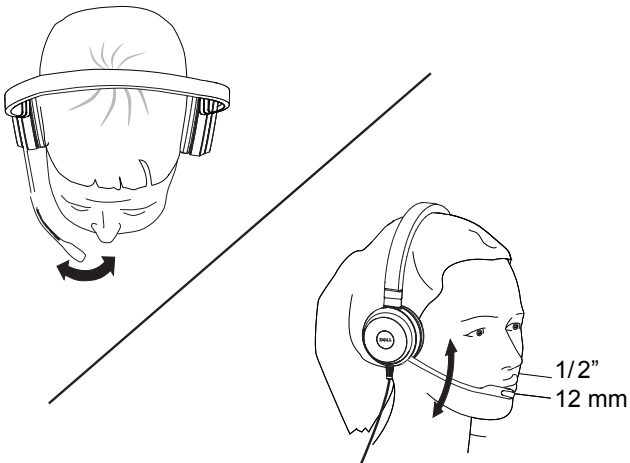
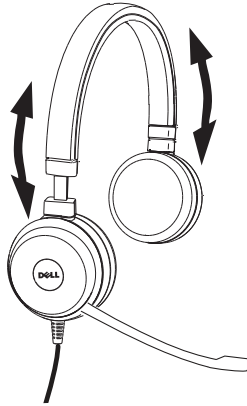

Answering/ending a call

Answer an incoming call on the computer

You will hear a ringtone on the headset on an incoming call from the soft phone. Answer the call by doing one of the following:

1. Accept the call on the softphone.
2. Press the Phone button on the headset as shown below.

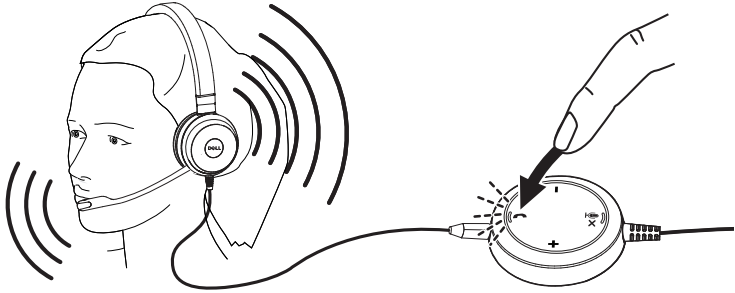

End an incoming call on the computer

Perform one of the following actions to terminate the call:

1. Press the end-call button on your softphone.
2. Press the Phone button on the headset as shown below.

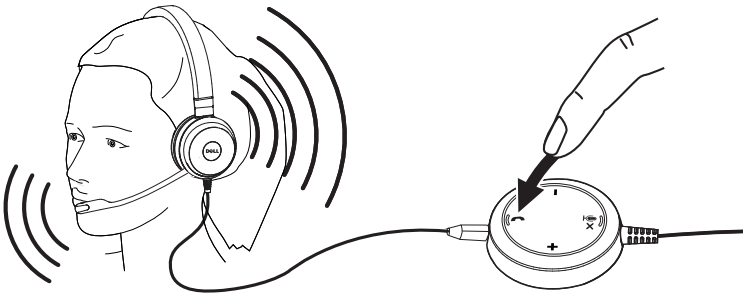

Adjusting the volume

Use the + and – button located at the center of the call control unit to adjust the volume. Press + to increase the volume level and – to decrease the volume as shown below.

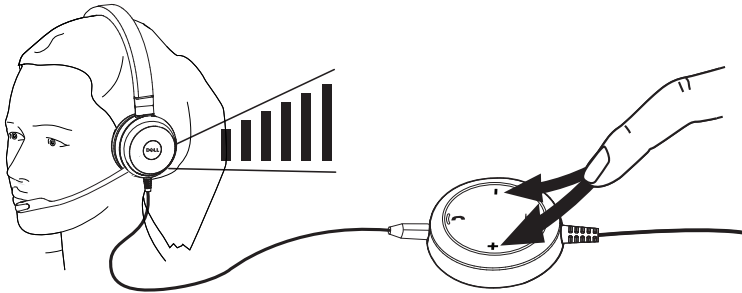

Muting/unmuting a call

Press the mute button to mute and unmute the microphone as shown below. Whenever the microphone is muted, a red LED glows indicating that the microphone is muted, and whenever the microphone is unmuted, the red LED stops.

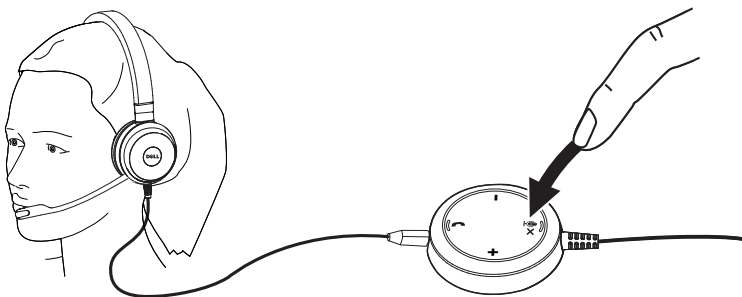

Troubleshooting

Common symptoms

The following table contains general information about common Dell Pro Stereo Headset UC350 symptoms you might encounter and the possible solutions.

Common symptoms	What you experience	Possible solutions
Headset does not power up upon connecting to the smartphone, tablet or PC	The red and green LEDs on the call-control unit are not glowing after connection	<ul style="list-style-type: none">• Make sure that the smartphone, tablet or PC is powered up.• Make sure that the headset is plugged into the smartphone or tablet through a 3.5 mm jack port, or the PC through a USB port.• Try using the headset on another smartphone, tablet or PC.
Smartphone, tablet or PC cannot detect the headset	Cannot be detected by the smartphone, tablet or PC	<ul style="list-style-type: none">• Make sure that the headset is plugged into the smartphone, tablet through a 3.5 mm jack port, or the PC through a USB port.• Try using the headset on another smartphone, tablet or PC
No audio in the headset –Using phone app on smartphone or tablet, or using Softphone on a PC	Cannot hear sound in the headset from phone app or softphone	<ul style="list-style-type: none">• Make sure that the headset is connected properly and powered up.• Make sure that the speaker volume is appropriately set on the headset.• Make sure that the speaker is not muted on the phone app or softphone and volume is set to the appropriate level.• Make sure that the caller has not muted his/her microphone.

<p>No audio in the headset –Using a media player on the smart phone, tablet or PC</p>	<p>Cannot hear sound in the headset from a media player</p>	<ul style="list-style-type: none"> • Make sure that the headset is connected properly and powered up. • Make sure that the speaker volume on the headset is set to an appropriate level. • Make sure that the speaker on the media player is not muted and volume is set to an appropriate level.
<p>Audio not clear in headset</p>	<p>The sound is not clear</p>	<ul style="list-style-type: none"> • Make sure that the speaker volume is set to an appropriate level • Make sure that the person on the other end has set the transmit volume to the appropriate level. • Make sure that the person on the other end, if using a headset, has positioned his/her microphone properly (close enough to the mouth - approximately 2 cm/less than 1 inch).
<p>No microphone audio from headset – Using phone app on Smartphone or tablet, or using Softphone on a PC</p>	<p>Person on the other end cannot hear you</p>	<ul style="list-style-type: none"> • Make sure that the headset is connected properly and powered up. • Make sure that the microphone is not muted, and the transmit volume is set to the appropriate level, both on the softphone and headset. • Make sure that the caller has not muted his/her speaker and that it is set to an appropriate level.

No microphone audio from headset – Using voice/recording application on smartphone, tablet or PC

Microphone does not work using voice/recording application

- Make sure that the headset is connected to the smartphone, tablet or PC and is powered up.
- Make sure that the Microphone on the headset is not muted.

Microphone audio not clear from headset

Person on the other end cannot hear you clearly

- Make sure that the microphone is close enough to the mouth - approximately 2 cm/less than 1 inch.
 - Make sure that the person on the other end has set the speaker (receive) volume on computer / desk phone and headset to the appropriate level.
-

Specifications

General

Model number	UC350
USB compliance	USB 2.0 (General and Audio Class specifications)
LED	Green for in use, red for mute
Supported operating systems	Windows 7 (32 and or 64 bit), Windows 8 and Windows 8.1, Windows 10

Physical characteristics

Weight	171 g without packaging
Dimension	Headset 181 mm x 151 mm x 54 mm Controller 54 mm x 14.5 mm
Cord length	PC to USB 0.95 m, USB to headset 1.2 m
Washable item	None (general cleaning with damp cloth)

Environmental

Operating temperature	+10° to +40° C
Operating humidity	5% to 93% relative humidity
Storage temperature	0° to +60° C

Statutory information

Warranty

Limited warranty and return policies

Dell-branded products carry a 1-year limited hardware warranty. If purchased together with a Dell system, it will follow the system warranty.

For U.S. customers:

This purchase and your use of this product are subject to Dell's end user agreement, which you can find at www.dell.com/terms. This document contains a binding arbitration clause.

For European, Middle Eastern and African customers:

Dell-branded products that are sold and used are subject to applicable national consumer legal rights, the terms of any retailer sale agreement that you have entered into (which will apply between you and the retailer) and Dell's end user contract terms.

Dell may also provide an additional hardware warranty – full details of the Dell end user contract and warranty terms can be found by going to www.dell.com, selecting your country from the list at the bottom of the “home” page and then clicking the “terms and conditions” link for the end user terms or the “support” link for the warranty terms.

For non-U.S. customers:

Dell-branded products that are sold and used are subject to applicable national consumer legal rights, the terms of any retailer sale agreement that you have entered into (which will apply between you and the retailer) and Dell's warranty terms. Dell may also provide an additional hardware warranty – full details of Dell's warranty terms can be found by going to www.dell.com, selecting your country from the list at the bottom of the “home” page and then clicking the “terms and conditions” link or the “support” link for the warranty terms.